







Parts List		
 Locking Ring	 Magnet Installation Tool with x2 magnets	 Qty:3 No6 x 1/2" Self tapping screw
 Charger	 Self Adhesive EPDM Rubber	 Alcohol wipe

Technical Information	
Input voltage range	10-30V DC (12 /24V system)
Input current max	2A
Output power	10W (9V, 1.1A)
Standby power draw	< 0.2W
Waterproof rating	IPX6 front and back
Certifications	Qi, CE, UKCA, FCC, ROHS, UNECE R10 E24, RCM, PSE, IC

Tools Required		
 Pozi Screwdriver	 Straight Router	 Silkaflex 292-i (Optional)

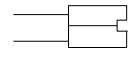
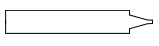

READ THE IMPORTANT SAFETY INFORMATION LEAFLET BEFORE INSTALLING

① If mounting surface is thinner than 3mm go to step 2. If greater than 3mm, rout a pocket 67mm (2.6") diameter till 3mm thickness is achieved.

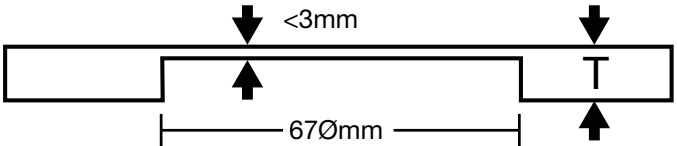

② Screw or bond locking ring in correct orientation to underside of surface according to the measured material thickness (Sikaflex 292-i recommended).

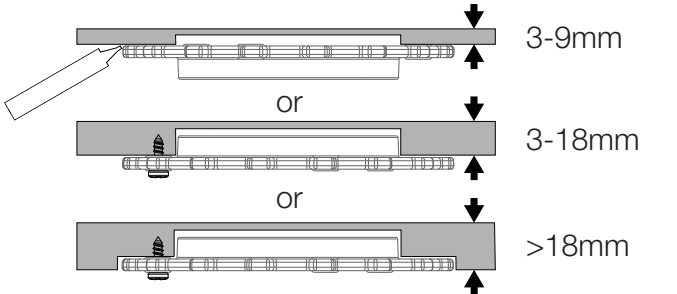

③a Option 1 - CNC etch logo onto top surface.
Do not exceed 0.5mm.

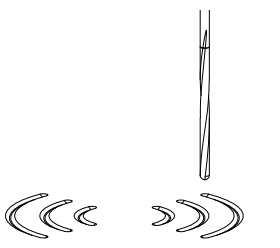

③b Option 2 - Use adhesive EPDM rubber and align with magnet tool provided. Use Alcohol wipe to ensure surface is free from dirt or grease.

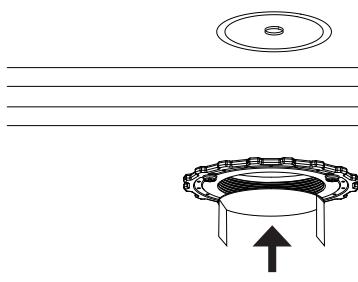

④ Screw in charger until firm, do not over tighten. Do not use tool.

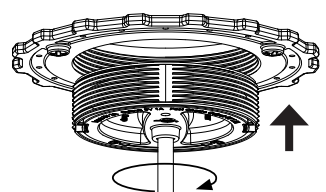

⑤ Connect wires to 12/24V supply, ensuring a waterproof connection. Fuse according to input voltage and current.

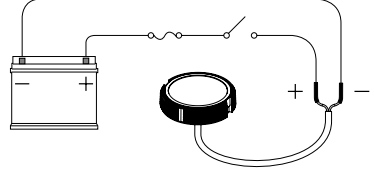
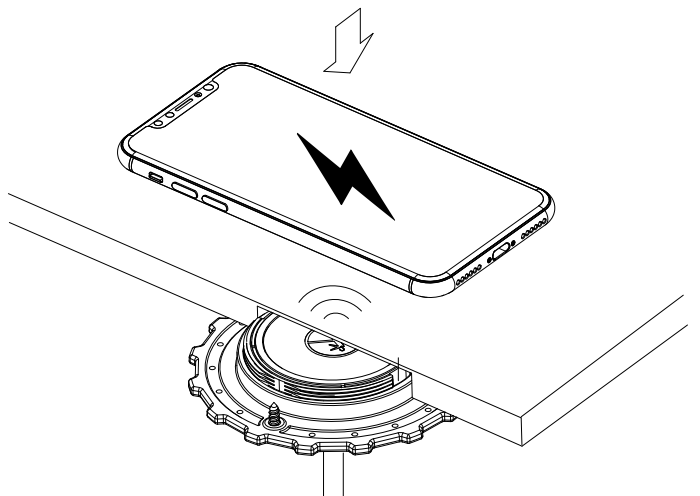
Share your installation with us.



@scanstrut

UK & International
+44 (0)1392531280
sales@scanstrut.com

For further installation and warranty information please visit:
www.scanstrut.com

USA
+1 860 308 1416
usasales@scanstrut.com

SCANSTRUT